

Signal lights / 808/809/818

LED Flashing Beacon BM 24VDC RD



Part No.: 808.179.55



MECHANICAL DATA	
Height	79 mm
Diameter	71 mm
Materials	PC PC/ABS
Dome colour	Red
Housing colour	Black
Protection category	IP65
cross-sectional area minimum	0,34mm ² / 22AWG
cross-sectional area maximum	2,50mm ² / 14AWG
Cable entry	Through hole
Cable entry maximum	d = 14 mm
Tension relief	Pull-out protection
Type of fixing	Base mounting
Working temperature minimum	-30°C
Working temperature maximum	+50°C
Weight with packaging	78 g
Product weight	78 g
ELECTRICAL DATA	
Operating voltage	24V
Operating voltage type	DC
Operating voltage tolerance	+/- 10%
Rated operational voltage	24 VDC
Rated operational current	70 mA
Rated inrush current	1.000 mA
Protection class	Protection class 2
Pollution degree	3
OPTICAL DATA	
Light source	LED
Light colour	Red
Optical signal image	Flash
Flash frequency	1 Hz
Service life optical	50,000 h maximum
APPROVAL DATA	
Conforms with CE	Yes
WEEE	Yes
Conforms with ATEX-directive	No



For additional installation and mounting information, refer to the appropriate user guide at www.werma.com. This printed copy is for information only and is subject to alteration.

Signal lights / 808/809/818

LED Flashing Beacon BM 24VDC RD

Conforms with CCC	No
Conforms with UL	No
Conforms with FCC	No
Conforms with IC	No
EAC certificate available	No
Conforms with UKCA (Importer)	Yes (WERMA (UK) Ltd.)
Conforms with AS-I	No
ICAO Certification	No
Conforms with DNV	No
Conforms with RoHS CN	25 years
Conforms with VdS	No

DRAWING

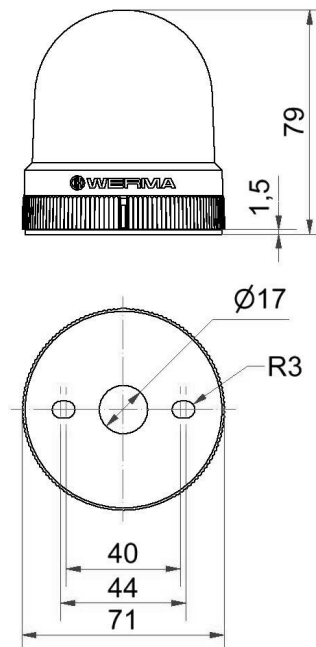

! For additional installation and mounting information, refer to the appropriate user guide at www.werma.com. This printed copy is for information only and is subject to alteration.